

ECKA G-115L Left

Technical data
State 11/2023

Technical data	Natural gas		Propane	
	G20	G25	G30	G31
Category				
Operational Data				
Nominal heat power	8,3 kW	7,1 kW	6,6 kW	6,0 kW
Reduced power (Eko mode)	1,8 kW	1,6 kW	1,8 kW	1,6 kW
Efficiency	82,1 %	80,9 %	81,2 %	80,8 %
Gas consumption at nominal heat power	1,087 m ³ /hod	1,087 m ³ /hod	0,257 m ³ /hod	0,257 m ³ /hod
Gas pressure	20 mbar	20 mbar	28 / 30 mbar	30 mbar
Data for convection enclosure				
Minimal grill area supply / outgoing	350 / 350 cm ²			
Minimum distance from insulated areas / floor	30 / 100 mm			
Calciumsilikat insulation ¹ ceiling / back wall / side wall / floor	30 / 40 / 40 / 0 mm			
Daten für Bauweise mit Strahlungsgehäuse				
Minimum radiant area ²	4 m ²			
Minimal grill area supply / outgoing	400 / 400 cm ²			
Minimum distance from insulated areas / floor	30 / 100 mm			
Calciumsilikat insulation ¹ ceiling / back wall / side wall / floor	40 / 40 / 40 / 0 mm			
General technical information				
Smoke outlet	130 / 200 mm			
Installation type	C11 / C31 / C91			
Gas connection	1/2 inch			
Total weight / with ribbed lining	152 kg / 202 kg			
Tested according to	EN 613			

¹ Example SkamoEnclosure Board 225 kg/m³.

² Depends on accumulation period and material characteristics.

Listed values calculated with chamotte stone thickness 30 mm with radiant area 500 W/m².

ECKA G-115L Left

Technical data
State 11/2023

ECKA G-115L Build-on frame 4/30 mm

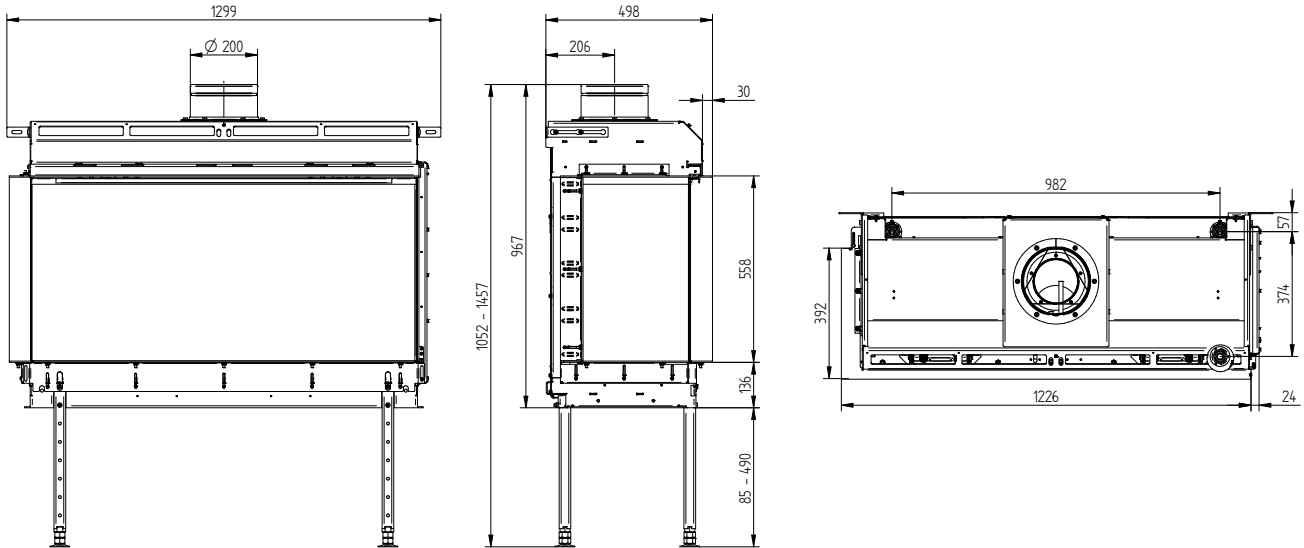

ECKA G-115L Build-on frame 8/55 mm

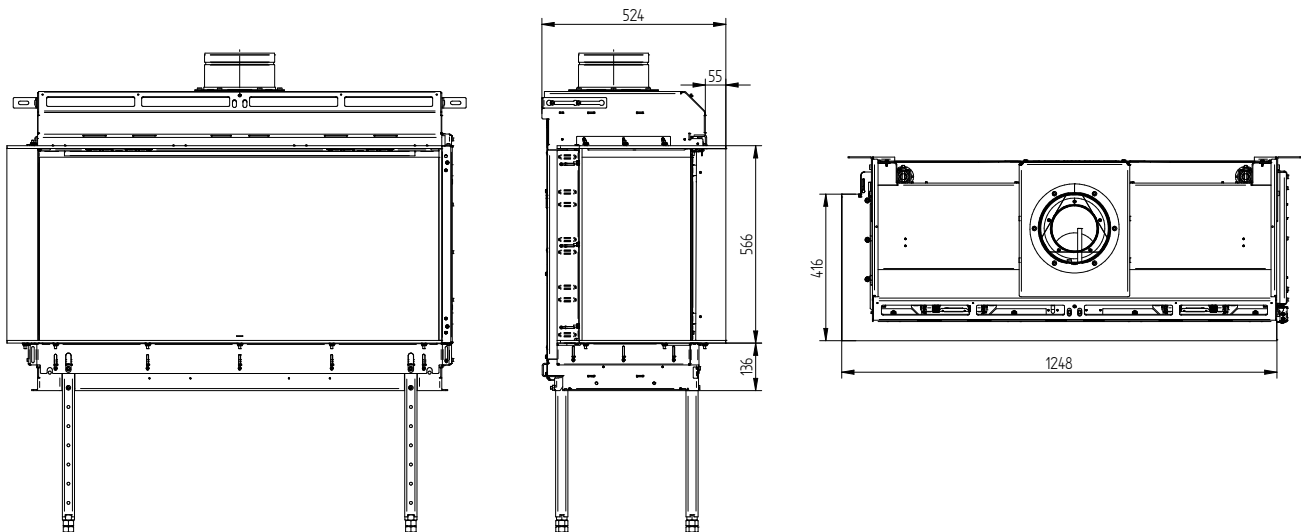

ECKA G-115L Left

Technical data
State 11/2023

ECKA G-115L Build-on frame 8/85 mm

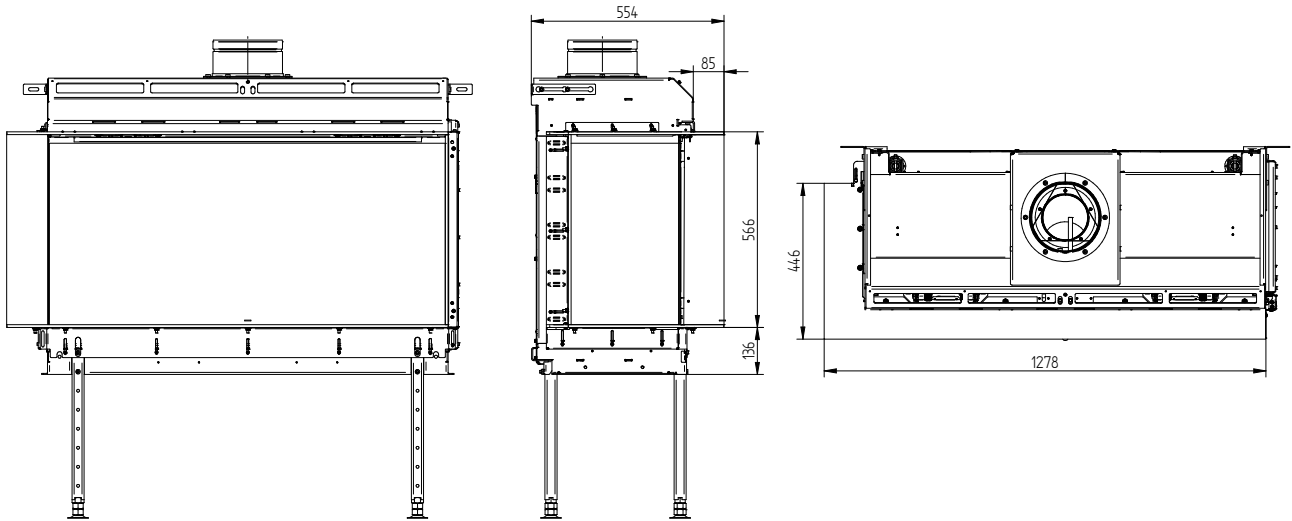

ECKA G-115L Convection jacket

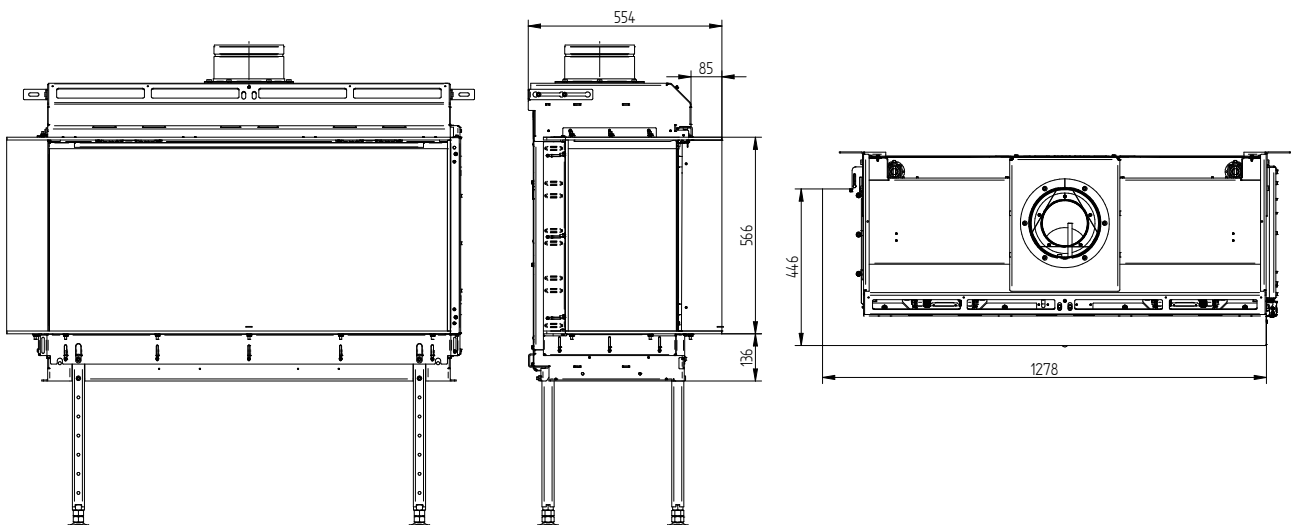

ECKA G-115L Left

Technical data
State 11/2023

ECKA G-115L Accumulation bricks

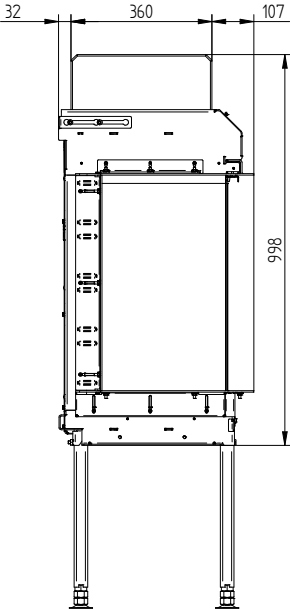
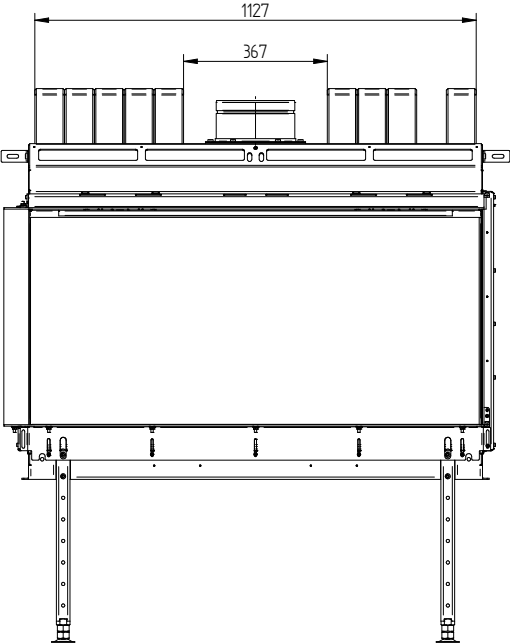

ECKA G-115R Right

Technical data
State 11/2023

Technical data	Natural gas		Propane	
	G20	G25	G30	G31
Category				
Operational Data				
Nominal heat power	8,3 kW	7,1 kW	6,6 kW	6,0 kW
Reduced power (Eko mode)	1,8 kW	1,6 kW	1,8 kW	1,6 kW
Efficiency	82,1 %	80,9 %	81,2 %	80,8 %
Gas consumption at nominal heat power	1,087 m ³ /hod	1,087 m ³ /hod	0,257 m ³ /hod	0,257 m ³ /hod
Gas pressure	20 mbar	20 mbar	28 / 30 mbar	30 mbar
Data for convection enclosure				
Minimal grill area supply / outgoing	350 / 350 cm ²			
Minimum distance from insulated areas / floor	30 / 100 mm			
Calciumsilikat insulation ¹ ceiling / back wall / side wall / floor	30 / 40 / 40 / 0 mm			
Daten für Bauweise mit Strahlungsgehäuse				
Minimum radiant area ²	4 m ²			
Minimal grill area supply / outgoing	400 / 400 cm ²			
Minimum distance from insulated areas / floor	30 / 100 mm			
Calciumsilikat insulation ¹ ceiling / back wall / side wall / floor	40 / 40 / 40 / 0 mm			
General technical information				
Smoke outlet	130 / 200 mm			
Installation type	C11 / C31 / C91			
Gas connection	1/2 inch			
Total weight / with ribbed lining	152 kg / 202 kg			
Tested according to	EN 613			

¹ Example SkamoEnclosure Board 225 kg/m³.

² Depends on accumulation period and material characteristics.

Listed values calculated with chamotte stone thickness 30 mm with radiant area 500 W/m².

ECKA G-115R Right

Technical data
State 11/2023

ECKA G-115R Build-on frame 4/30 mm

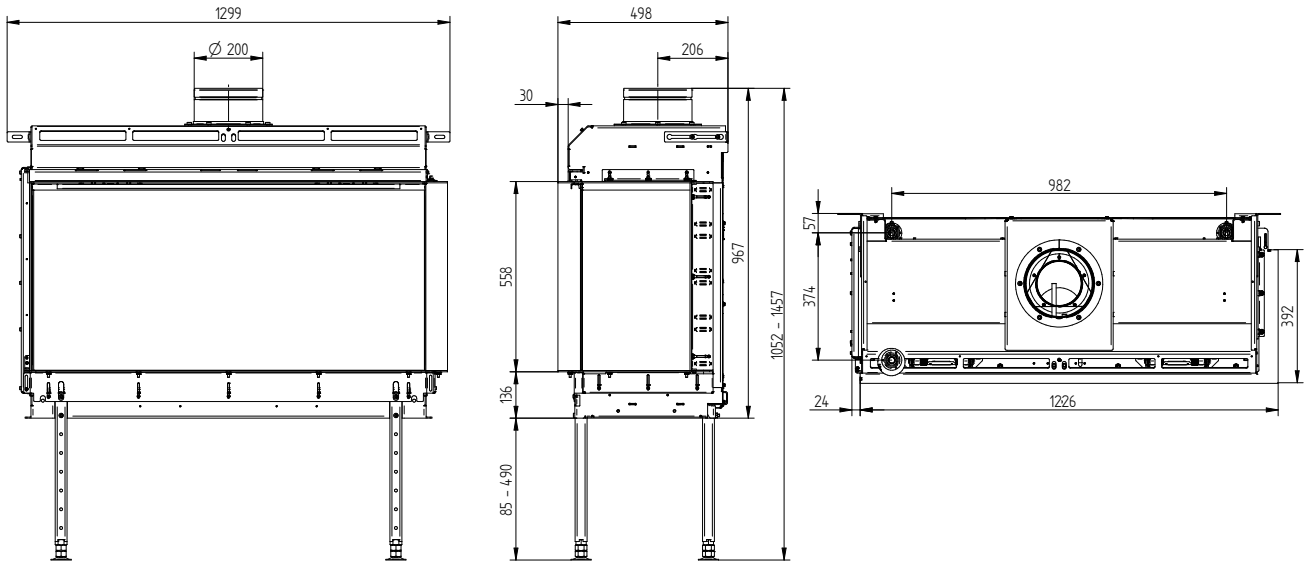

ECKA G-115R Build-on frame 8/55 mm

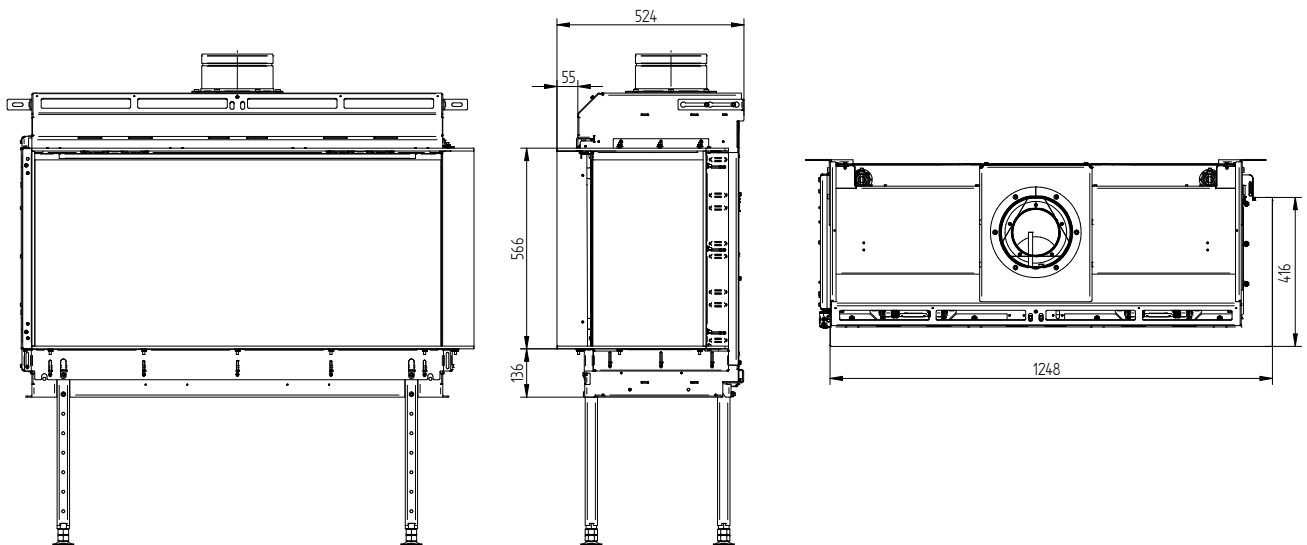

ECKA G-115R Right

Technical data
State 11/2023

ECKA G-115R Build-on frame 8/85 mm

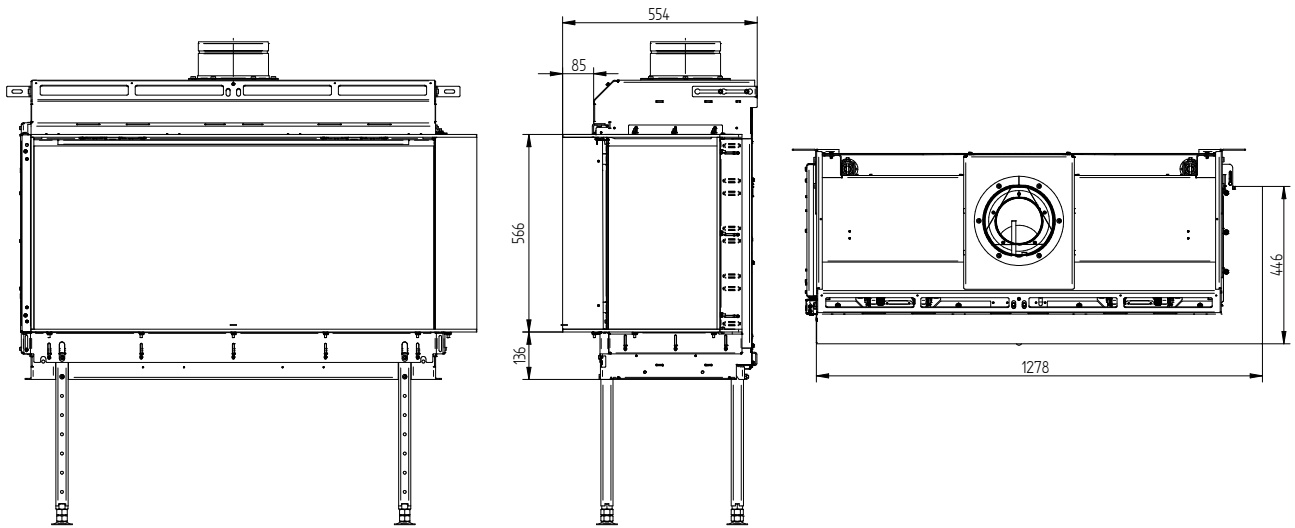

ECKA G-115R Convection jacket

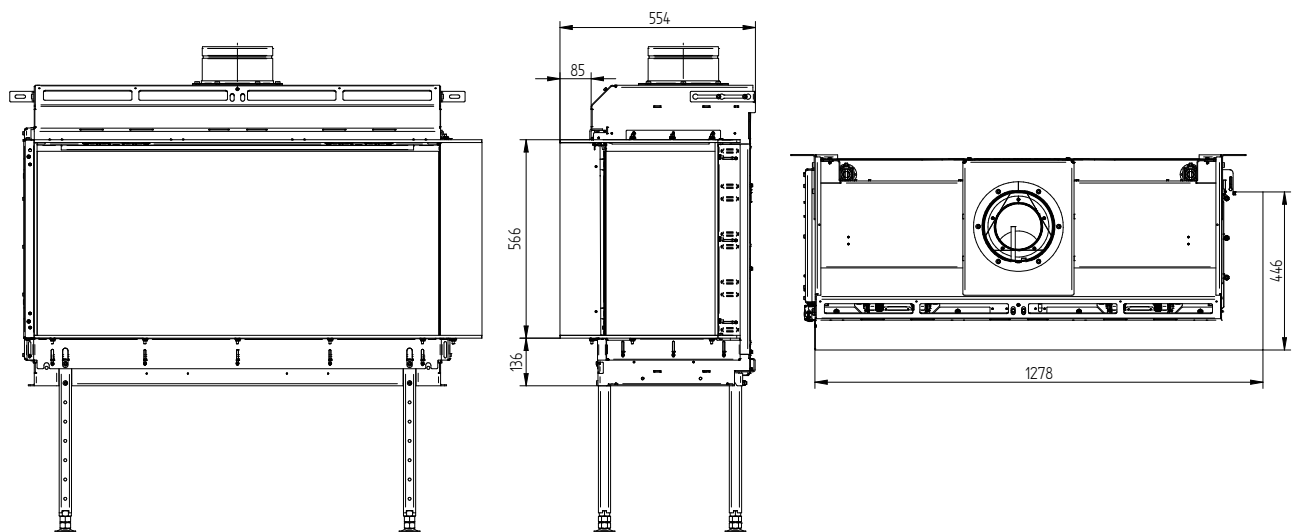

ECKA G-115R Right

Technical data
State 11/2023

ECKA G-115R Accumulation bricks

